

HFA16TB120PbF

Ultrafast, Soft Recovery Diode

HEXFRED™

Features

- Ultrafast Recovery
- Ultrasoft Recovery
- Very Low I_{RRM}
- Very Low Q_{rr}
- Specified at Operating Conditions
- Lead-Free

Benefits

- Reduced RFI and EMI
- Reduced Power Loss in Diode and Switching Transistor
- Higher Frequency Operation
- Reduced Snubbing
- Reduced Parts Count

Description

International Rectifier's HFA16TB120 is a state of the art ultra fast recovery diode. Employing the latest in epitaxial construction and advanced processing techniques it features a superb combination of characteristics which result in performance which is unsurpassed by any rectifier previously available. With basic ratings of 1200 volts and 16 amps continuous current, the HFA16TB120 is especially well suited for use as the companion diode for IGBTs and MOSFETs. In addition to ultra fast recovery time, the HEXFRED product line features extremely low values of peak recovery current (I_{RRM}) and does not exhibit any tendency to "snap-off" during the t_b portion of recovery. The HEXFRED features combine to offer designers a rectifier with lower noise and significantly lower switching losses in both the diode and the switching transistor. These HEXFRED advantages can help to significantly reduce snubbing, component count and heatsink sizes. The HEXFRED HFA16TB120 is ideally suited for applications in power supplies and power conversion systems (such as inverters), motor drives, and many other similar applications where high speed, high efficiency is needed.

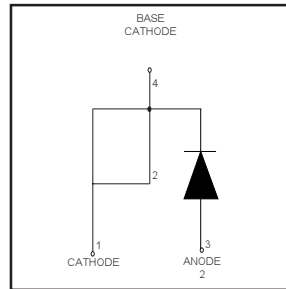

$V_R = 1200V$
$V_F(\text{typ.})^* = 2.3V$
$I_{F(AV)} = 16A$
$Q_{rr}(\text{typ.}) = 260nC$
$I_{RRM}(\text{typ.}) = 5.8A$
$t_{rr}(\text{typ.}) = 30ns$
$di_{(rec)}/dt(\text{typ.})^* = 76A/\mu s$

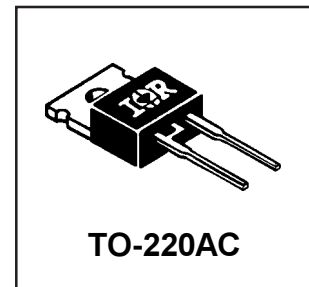

Absolute Maximum Ratings

	Parameter	Max	Units
V_R	Cathode-to-Anode Voltage	1200	V
$I_F @ T_C = 100^\circ C$	Continuous Forward Current	16	A
I_{FSM}	Single Pulse Forward Current	190	
I_{FRM}	Maximum Repetitive Forward Current	64	
$P_D @ T_C = 25^\circ C$	Maximum Power Dissipation	151	W
$P_D @ T_C = 100^\circ C$	Maximum Power Dissipation	60	
T_J	Operating Junction and	-55 to +150	$^\circ C$
T_{STG}	Storage Temperature Range		

* 125°C

Electrical Characteristics @ T_J = 25°C (unless otherwise specified)

	Parameter	Min	Typ	Max	Units	Test Conditions
V _{BR}	Cathode Anode Breakdown Voltage	1200			V	I _R = 100μA
V _{FM}	Max Forward Voltage		2.5	3.0	V	I _F = 16A
			3.2	3.93		I _F = 32A
			2.3	2.7		I _F = 16A, T _J = 125°C
I _{RM}	Max Reverse Leakage Current		0.75	20	μA	V _R = V _R Rated
			375	2000		T _J = 125°C, V _R = 0.8 x V _R Rated
C _T	Junction Capacitance		27	40	pF	V _R = 200V
L _S	Series Inductance		8.0		nH	Measured lead to lead 5mm from package body

Dynamic Recovery Characteristics @ T_J = 25°C (unless otherwise specified)

	Parameter	Min	Typ	Max	Units	Test Conditions
t _{rr}	Reverse Recovery Time		30			I _F = 1.0A, di _F /dt = 200A/μs, V _R = 30V
t _{rr1}	See Fig. 5, 10		90	135	ns	T _J = 25°C
t _{rr2}			164	245		T _J = 125°C
I _{RRM1}	Peak Recovery Current		5.8	10	A	T _J = 25°C
I _{RRM2}	See Fig. 6		8.3	15		T _J = 125°C
Q _{rr1}	Reverse Recovery Charge		260	675	nC	T _J = 25°C
Q _{rr2}	See Fig. 7		680	1838		T _J = 125°C
di _{(rec)M} /dt1	Peak Rate of Fall of Recovery Current		120		A/μs	T _J = 25°C
di _{(rec)M} /dt2	During t _b See Fig. 8		76			T _J = 125°C

Thermal - Mechanical Characteristics

	Parameter	Min	Typ	Max	Units
T _{lead} ①	Lead Temperature			300	°C
R _{thJC}	Thermal Resistance, Junction to Case			0.83	K/W
R _{thJA} ②	Thermal Resistance, Junction to Ambient			80	
R _{thCS} ③	Thermal Resistance, Case to Heat Sink		0.50		
Wt	Weight		2.0		g
			0.07		(oz)
	Mounting Torque		6.0	12	Kg-cm
			5.0	10	lbf-in

① 0.063 in. from Case (1.6mm) for 10 sec

② Typical Socket Mount

③ Mounting Surface, Flat, Smooth and Greased

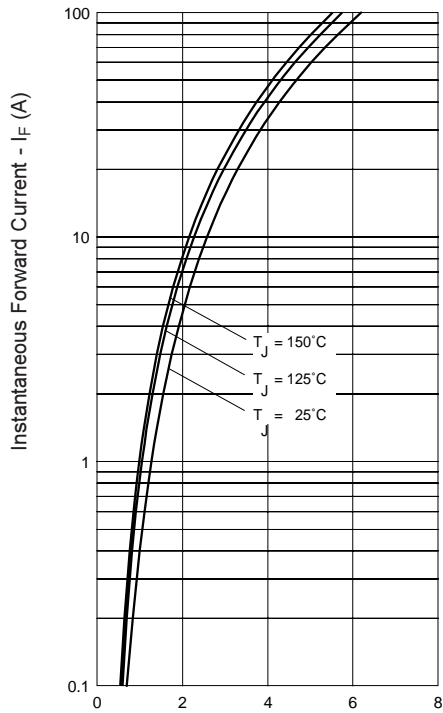

Fig. 1 - Maximum Forward Voltage Drop vs. Instantaneous Forward Current

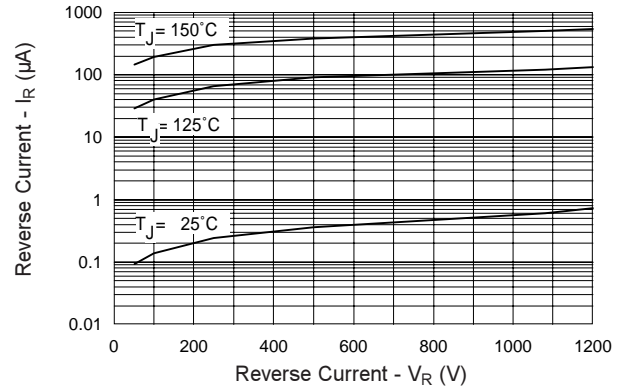

Fig. 2 - Typical Reverse Current vs. Reverse Voltage

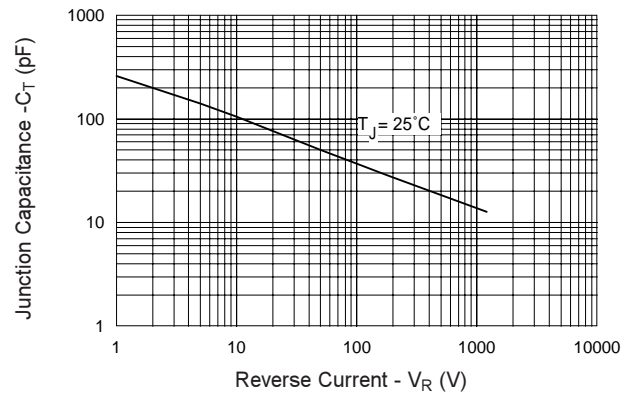

Fig. 3 - Typical Junction Capacitance vs. Reverse Voltage

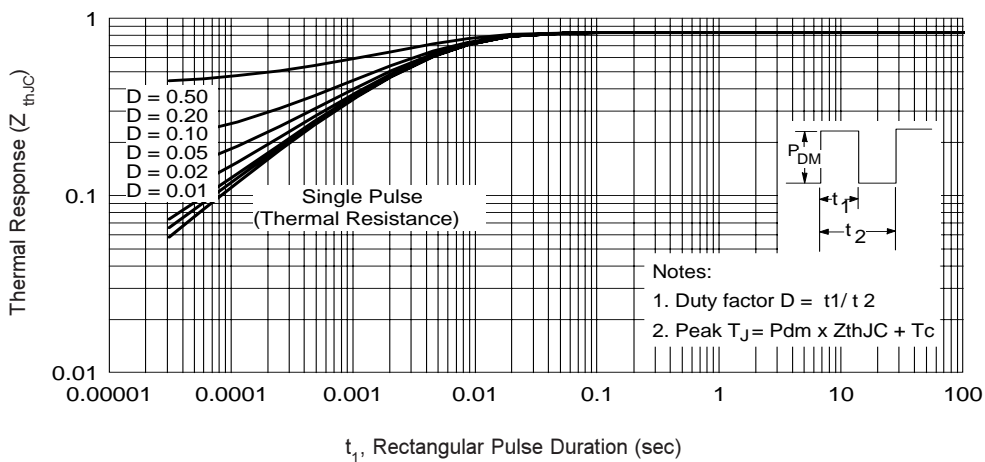

Fig. 4 - Maximum Thermal Impedance Z_{thJC} Characteristics

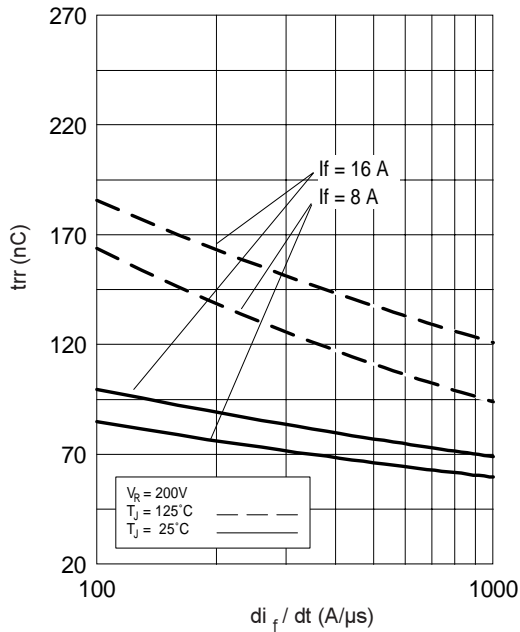

Fig. 5 - Typical Reverse Recovery vs. di_f/dt , (per Leg)

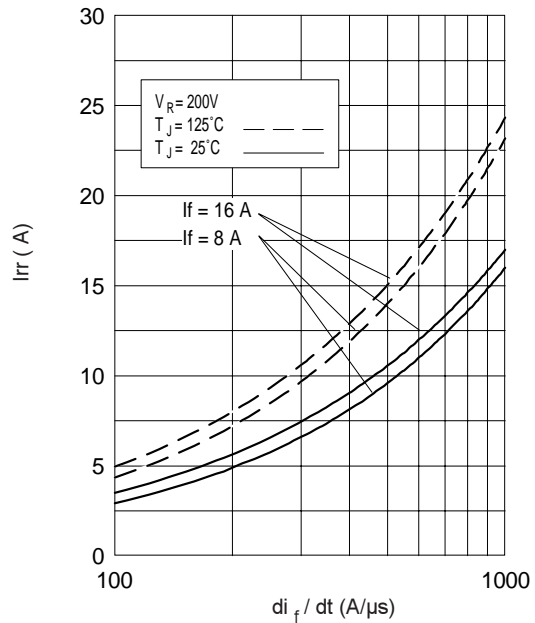

Fig. 6 - Typical Recovery Current vs. di_f/dt , (per Leg)

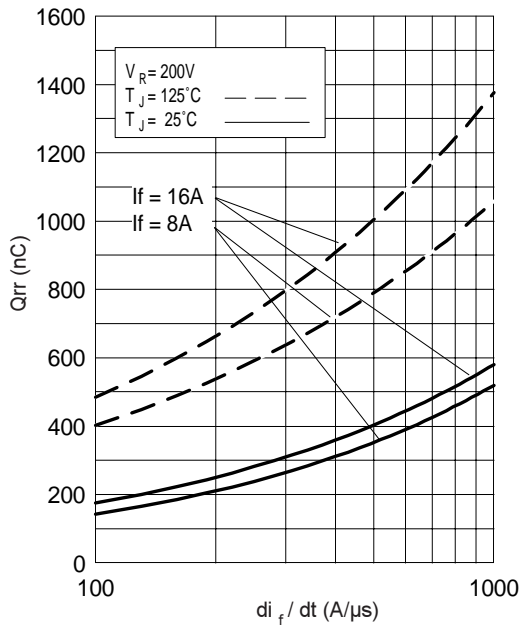

Fig. 7 - Typical Stored Charge vs. di_f/dt , (per Leg)

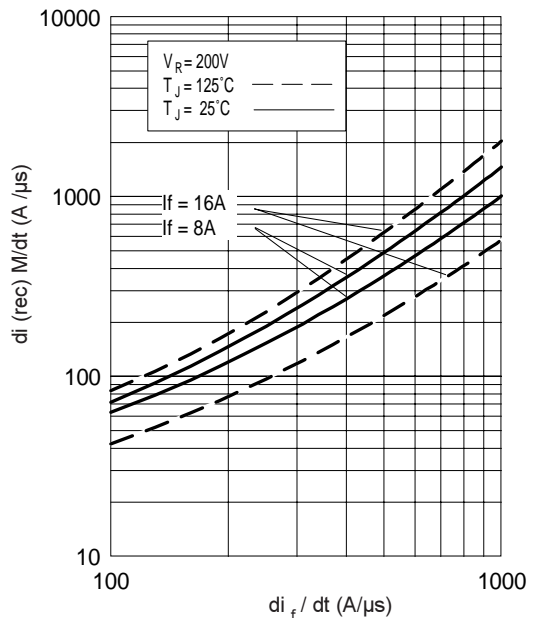

Fig. 8 - Typical $di_{(rec)M}/dt$ vs. di_f/dt , (per Leg)

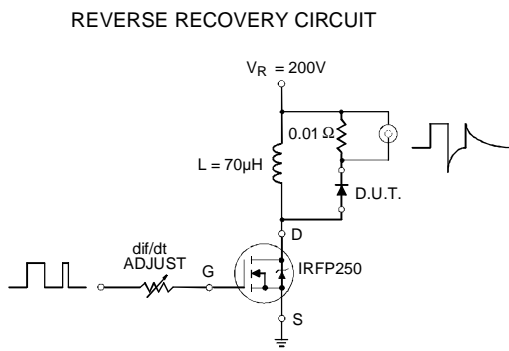
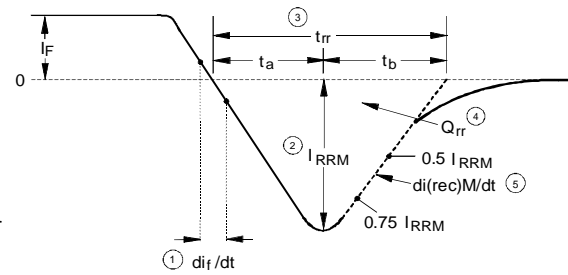

Fig. 9 - Reverse Recovery Parameter Test Circuit



1. di_f/dt - Rate of change of current through zero crossing
2. I_{RRM} - Peak reverse recovery current
3. t_{rr} - Reverse recovery time measured from zero crossing point of negative going I_F to point where a line passing through $0.75 I_{RRM}$ and $0.50 I_{RRM}$ extrapolated to zero current
4. Q_{rr} - Area under curve defined by t_{rr} and I_{RRM}
5. $di_{(rec)}/dt$ - Peak rate of change of current during t_b portion of t_{rr}

$$Q_{rr} = \frac{t_{rr} \times I_{RRM}}{2}$$

Fig. 10 - Reverse Recovery Waveform and Definitions

HFA16TB120PbF

TO-220AC Package Outline

Dimensions are shown in millimeters (inches)

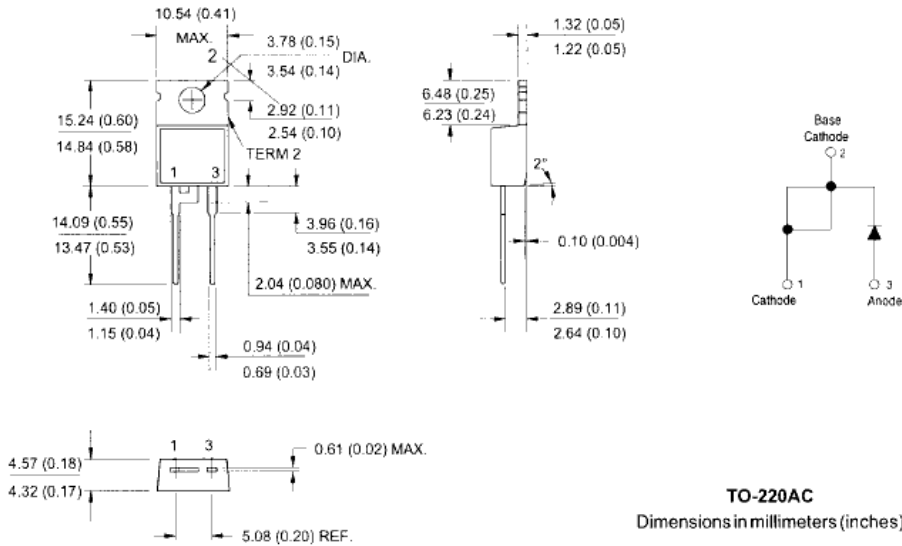

TO-220AC Part Marking Information

EXAMPLE: THIS IS A HFA06TB120
LOT CODE 1789
ASSEMBLED ON WW 19, 2001
IN THE ASSEMBLY LINE "C"

Note: "P" in the beginning of
date code indicates "Lead-Free"

OR

EXAMPLE: THIS IS A HFA06TB120
LOT CODE 1789
ASSEMBLED ON WW 19, 2001
IN THE ASSEMBLY LINE "C"

Note: "P" in assembly line
position indicates "Lead-Free"

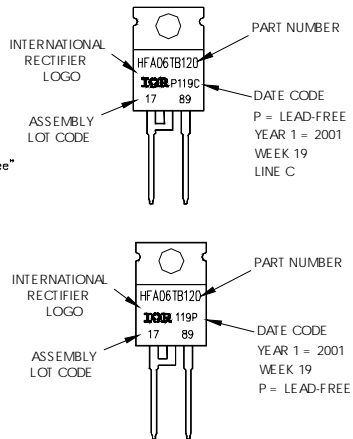

Data and specifications subject to change without notice.
This product has been designed and qualified for Industrial Level.
Qualification Standards can be found on IR's Web site.



IR WORLD HEADQUARTERS: 233 Kansas St., El Segundo, California 90245, USA Tel: (310) 252-7105
TAC Fax: (310) 252-7309

Visit us at www.irf.com for sales contact information. 10/04
www.irf.com